



SEALTEC®
sustainable waterproofing

Technisch dossier

Legende

P3: Standaard gecoate lashoek mechanisch bevestigd

P4: Standaard gecoate lashoek verlijmd

P5: Aansluiting randprofiel

P6: Aansluiting omgekeerd randprofiel

P7: Aansluiting renovatieprofiel

P8: Standaard gecoate lashoekverhoogd

P9: Aansluiting platte lasstrip

P10: Wandaansluitprofiel

P11: Afdekking gecoate lashoek Sealbond Coverstrip

P12: Afdekking randprofiel Sealbond Coverstrip

P13: Aansluiting bestaande folie

P14: Aansluiting Haklin voegband

P15: Principeschets vloeropbouw (WoV)

P16: Principeschets vloeropbouw (VoW)

P17: SealDrain

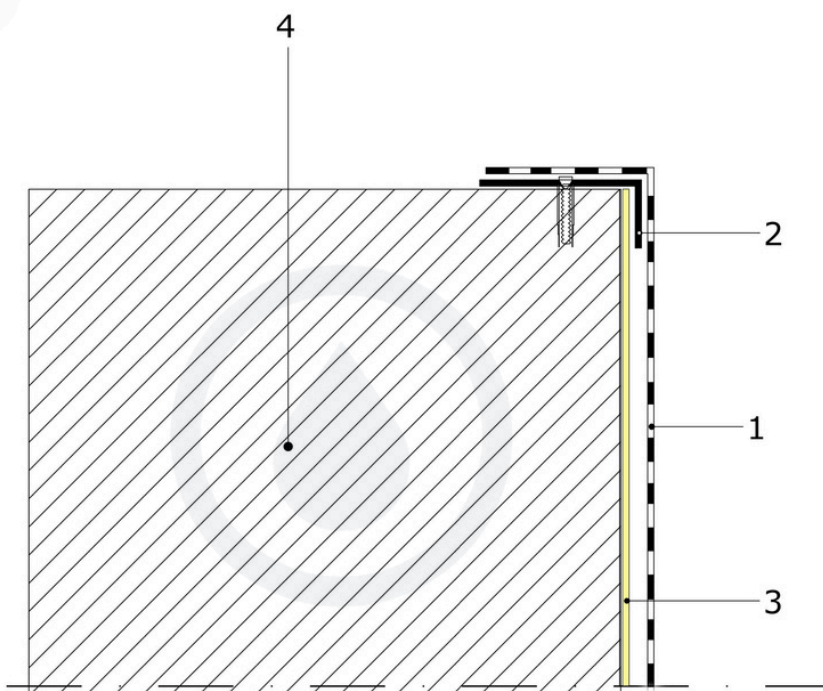
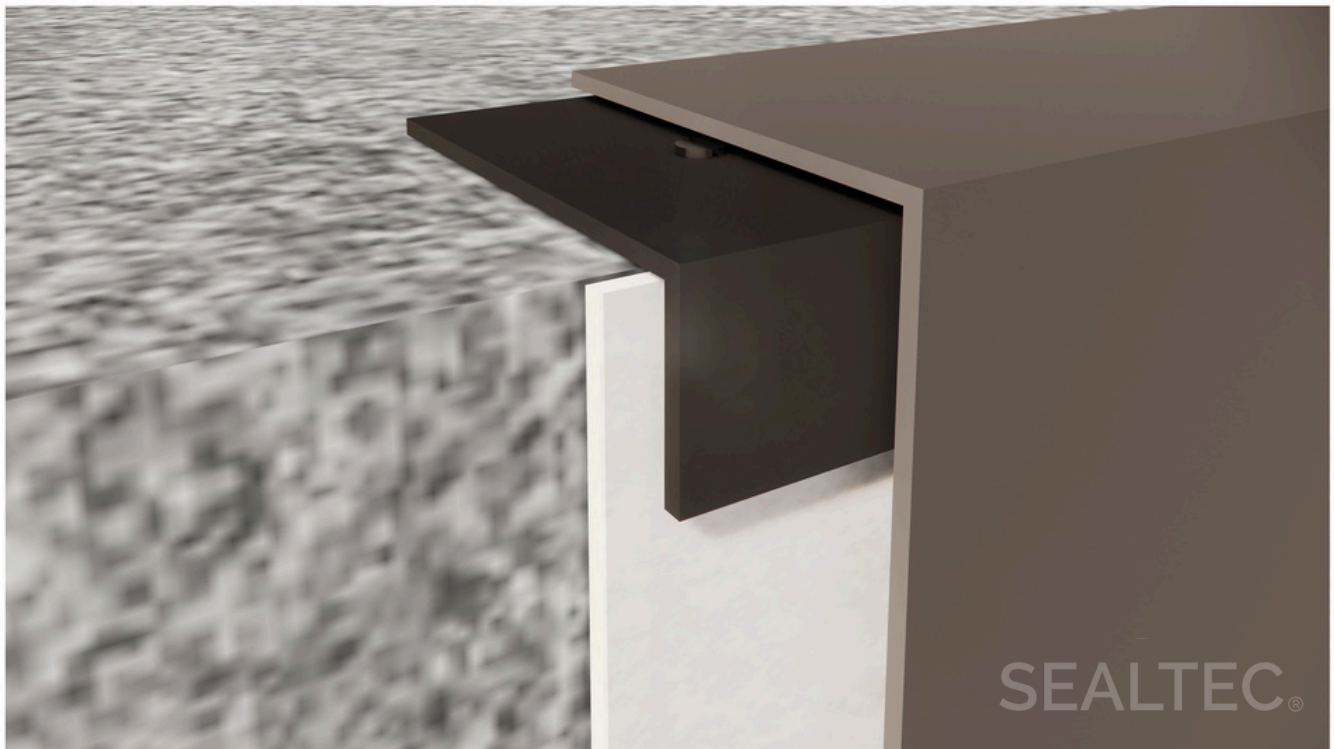

- 1. Sealtec TPO
- 2. Gecoate Lashoek
- 3. Geotextiel / Softouch Premium
- 4. Wand

02. Standaard gecoate lashoek verlijmd

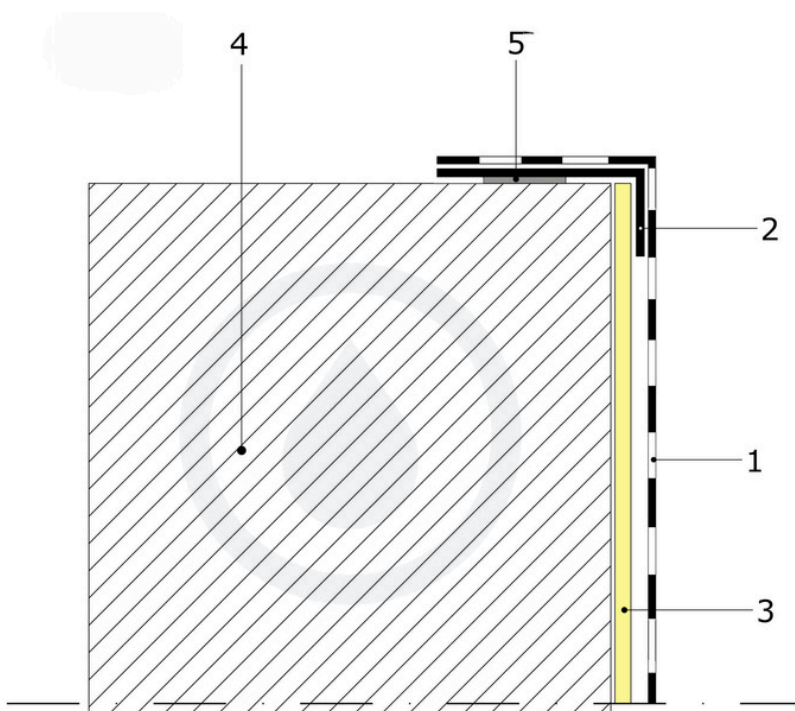

- 1. Sealtec TPO
- 2. Gecoate lashoek
- 3. SoftTouch Premium / Geotextiel
- 4. Wand
- 5. Constructie lijm

03. Aansluiting randprofiel

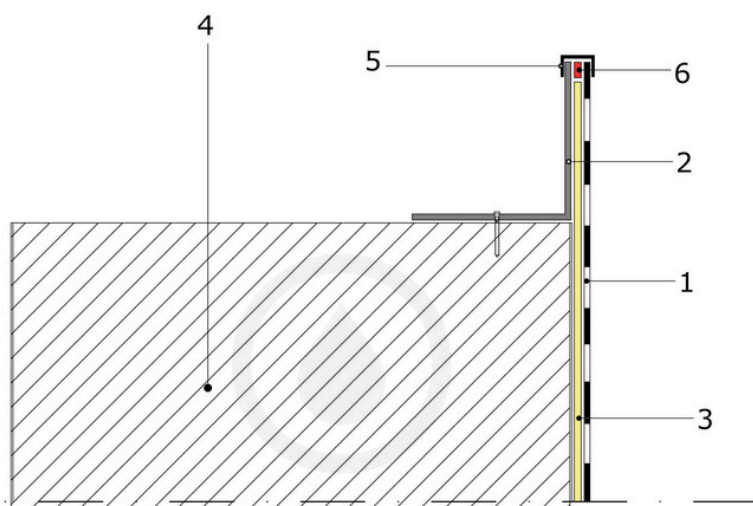
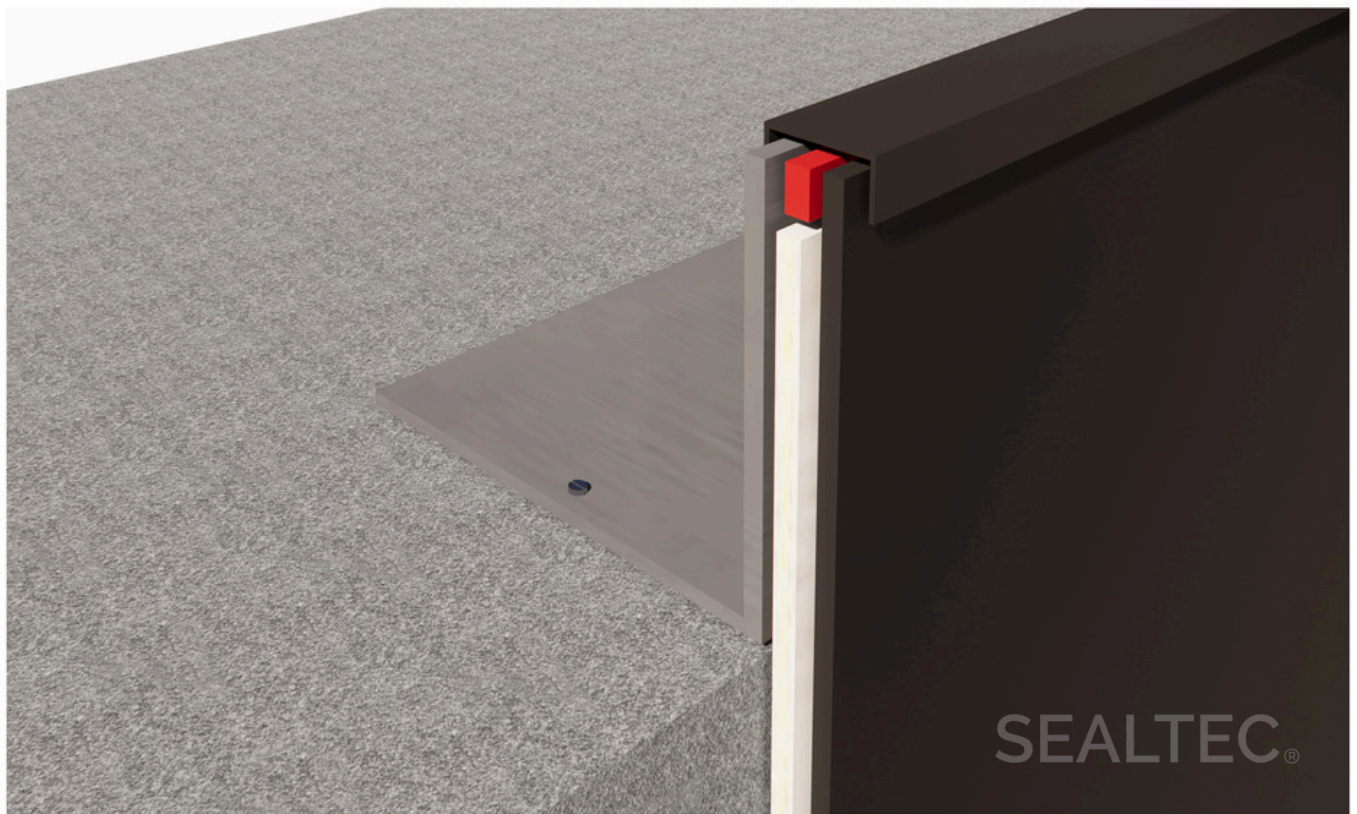

- 1. Sealtec TPO
- 2. Randprofiel
- 3. Geotextiel
- 4. Wand
- 5. Kantafwerkprofiel
- 6. Powder coating tape

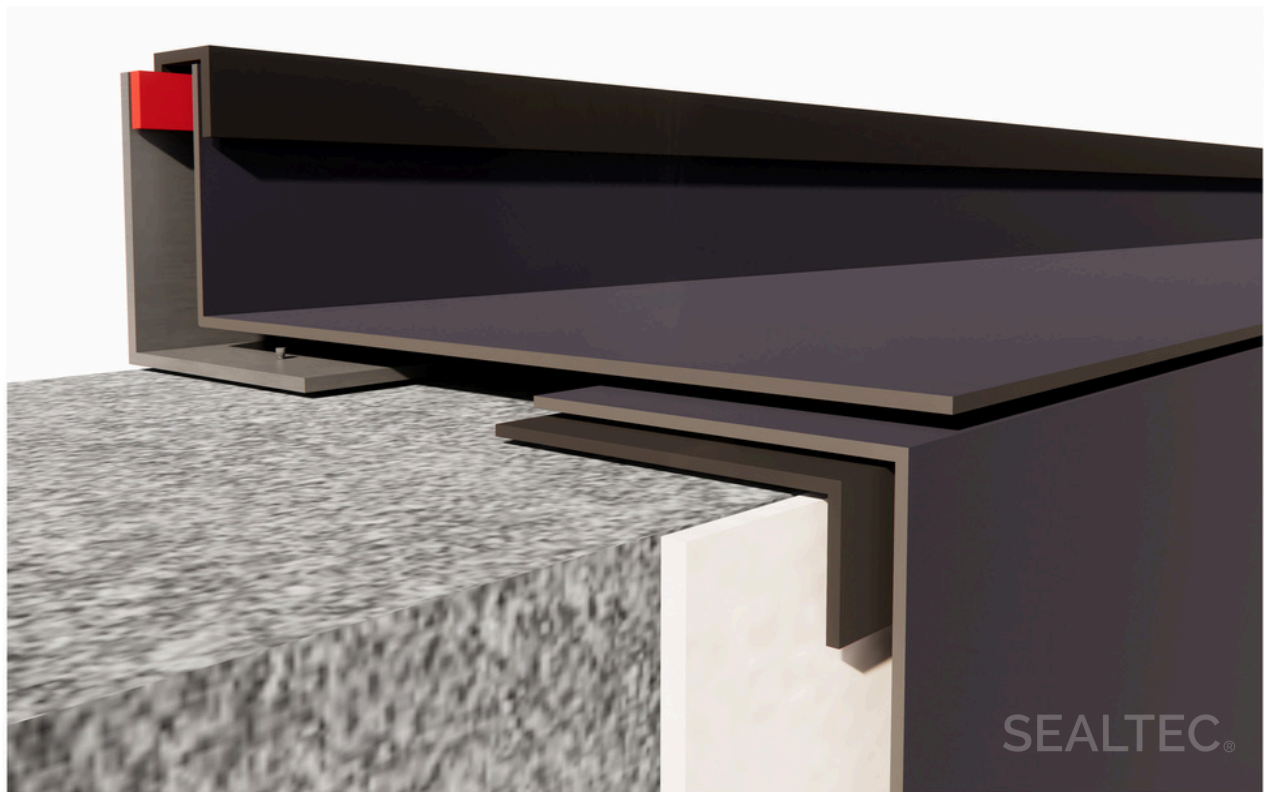

SEALTEC®

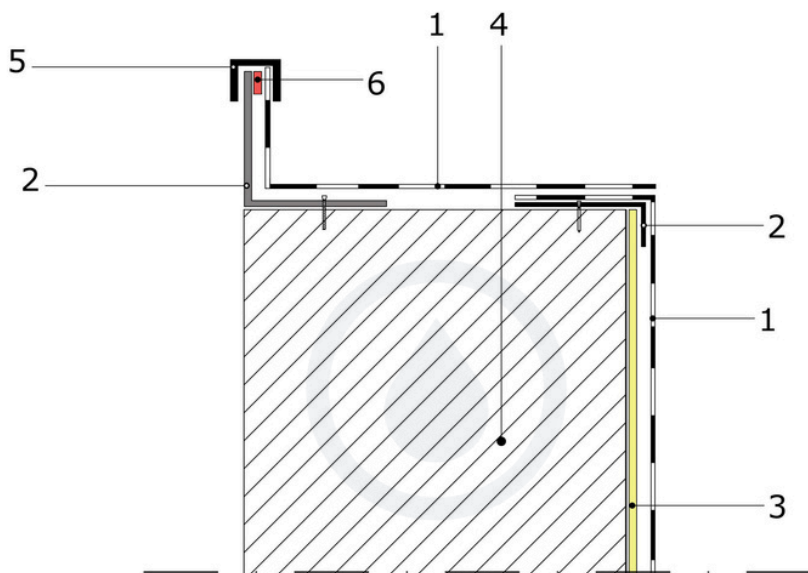

- 1. Sealtec TPO
- 2. Randprofiel
- 3. Geotextiel / SoftTouch Premium
- 4. Wand
- 5. Kantafwerkprofiel
- 6. Powder coating tape

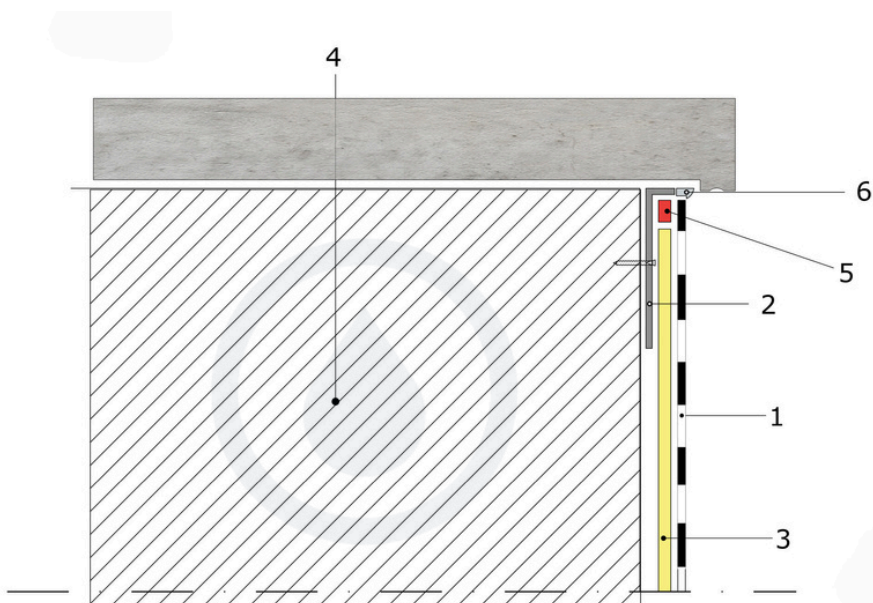

- 1. Sealtec TPO
- 2. Renovatieprofiel
- 3. Geotextiel
- 4. Wand
- 5. Powder coating tape
- 6. Siliconen voeg

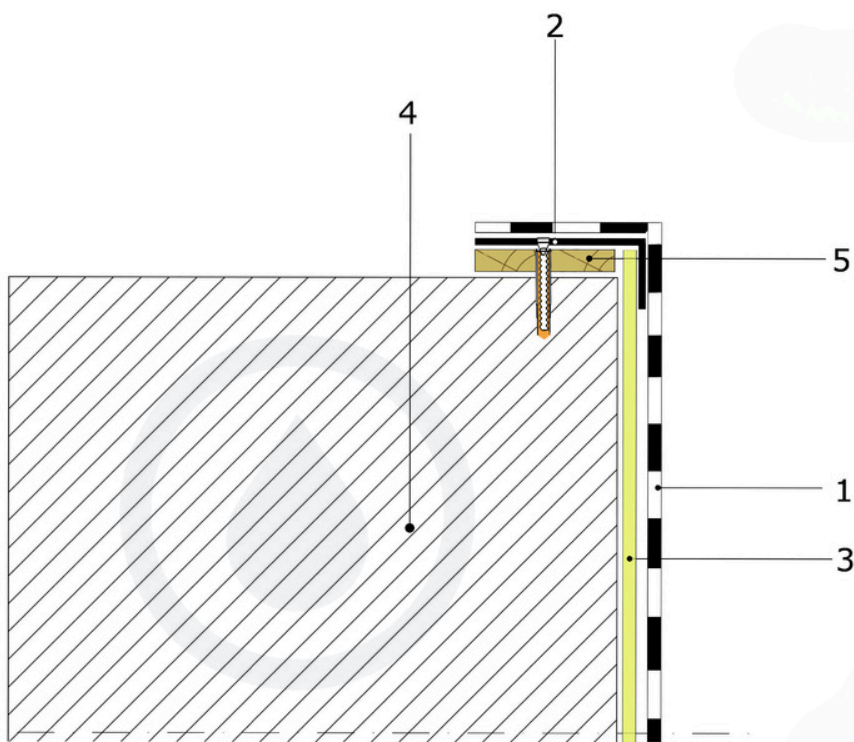
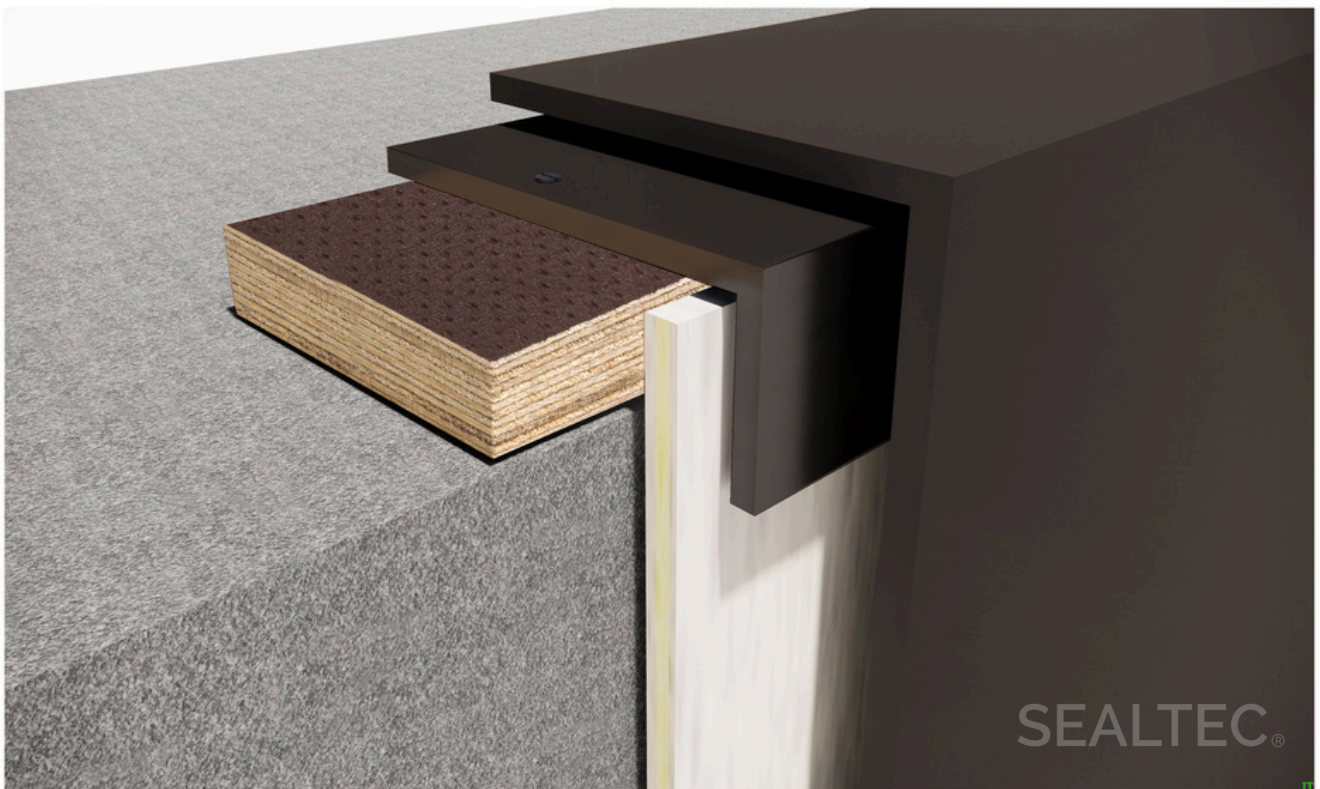

- 1. Sealtec TPO
- 2. Gecoate lashoek
- 3. Geotextiel / SoftTouch Premium
- 4. Wand
- 5. Betonplex

07. Aansluiting_platte lasstrip

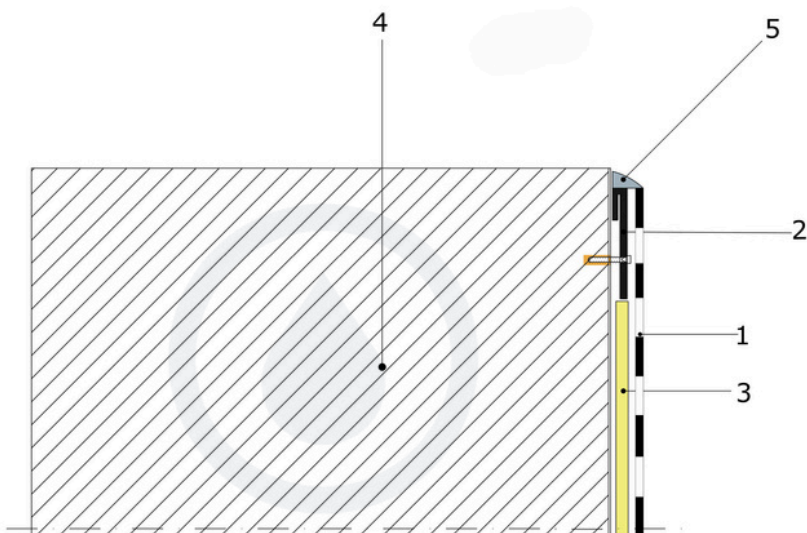

- 1. Sealtec TPO
- 2. Lasstrip
- 3. Geotextiel
- 4. Wand
- 5. Siliconenvoeg

08. Wandaansluitprofiel

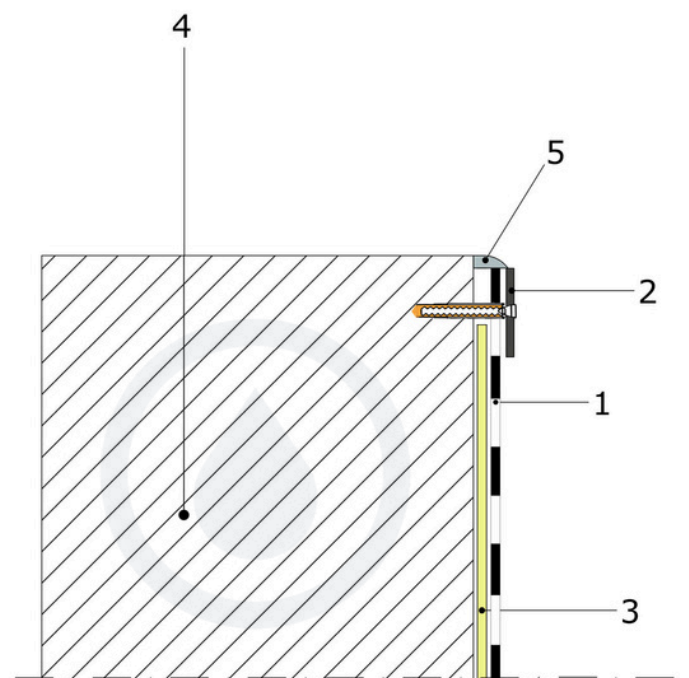

- 1. Sealtec TPO
- 2. Wandaansluitprofiel
- 3. Geotextiel
- 4. Wand
- 5. Siliconenvoeg

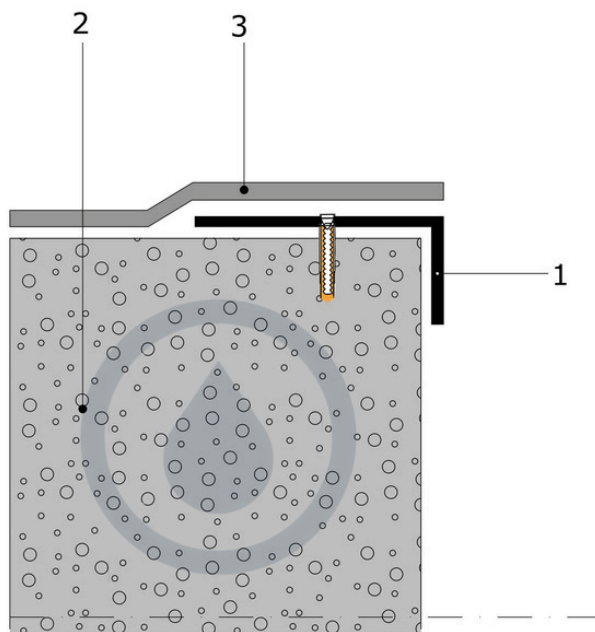
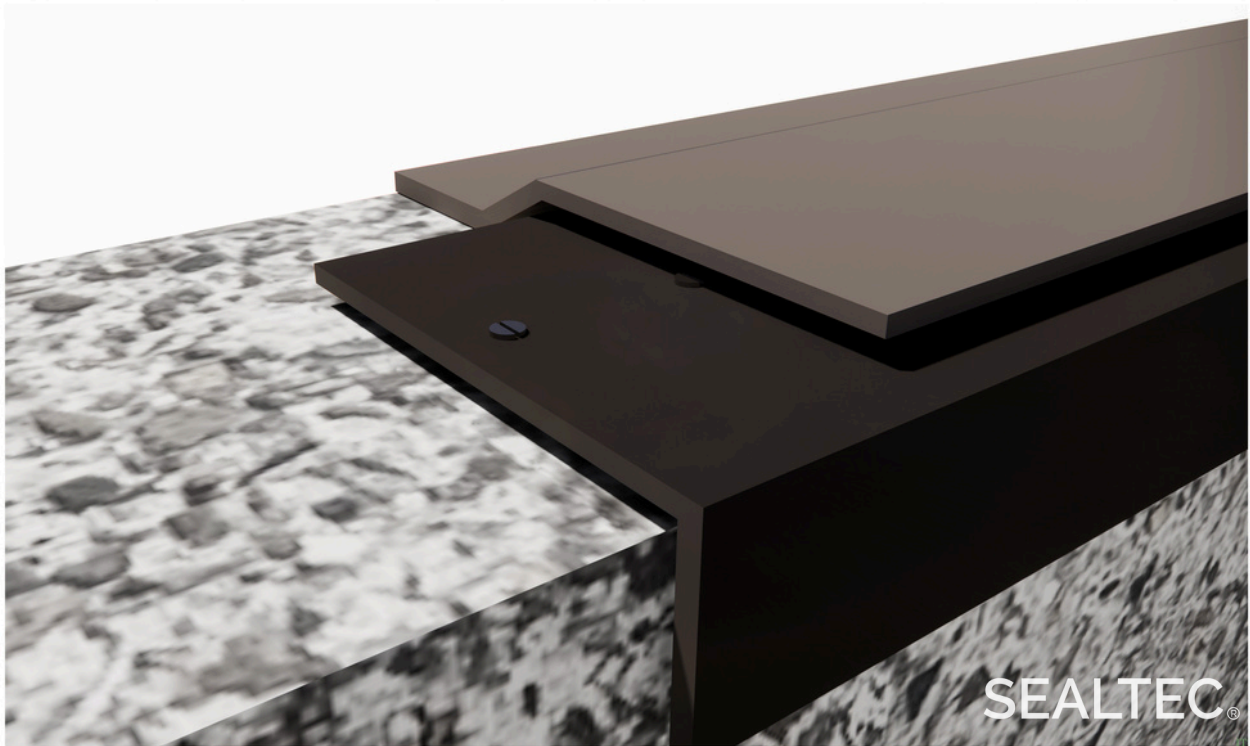

- 1. Gecoate lashoek
- 2. Beton
- 3. Sealbond Coverstrip

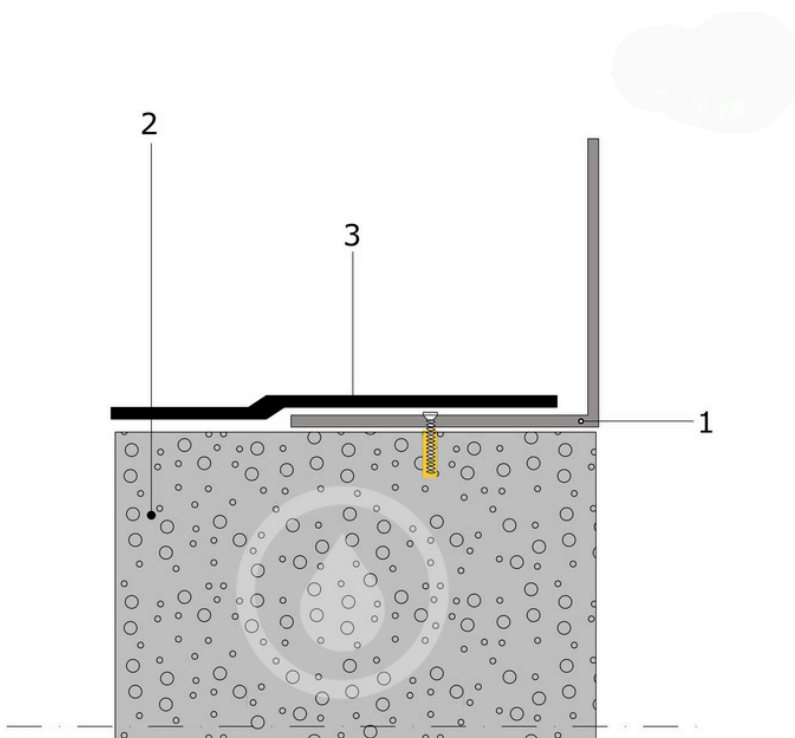
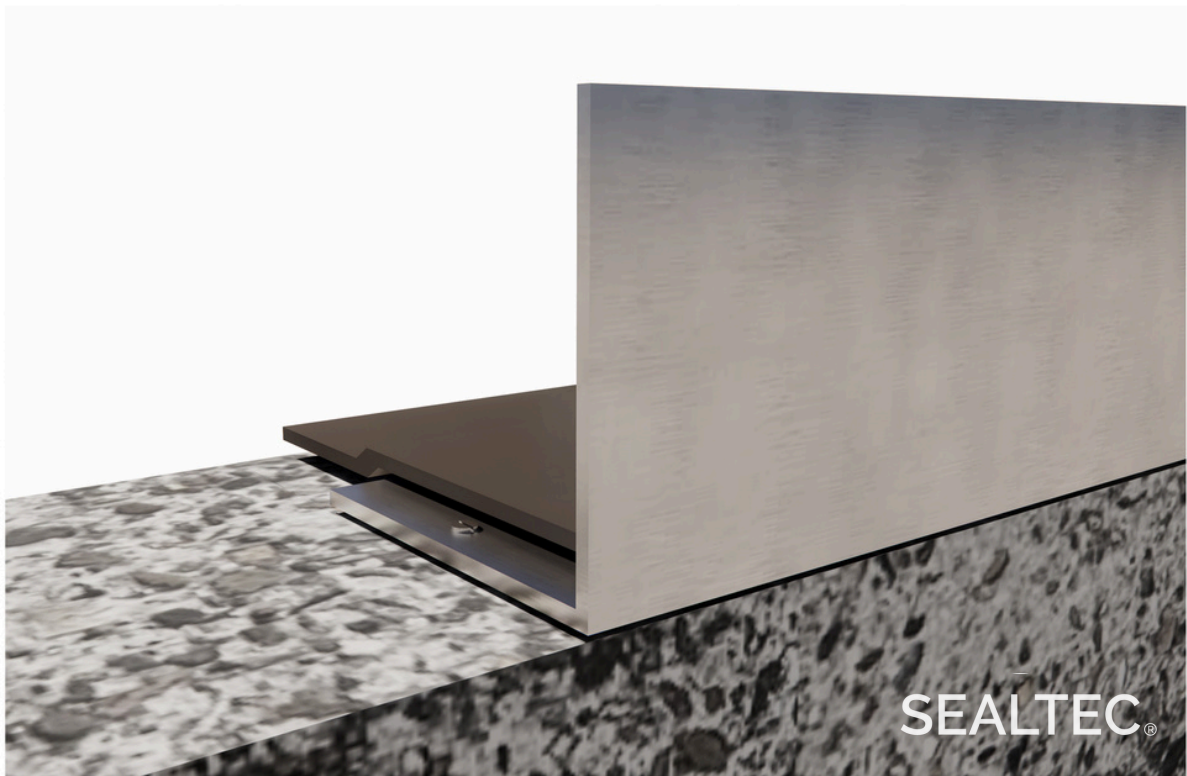

- 1. Hoekprofiel
- 2. Beton
- 3. Sealbond Coverstrip

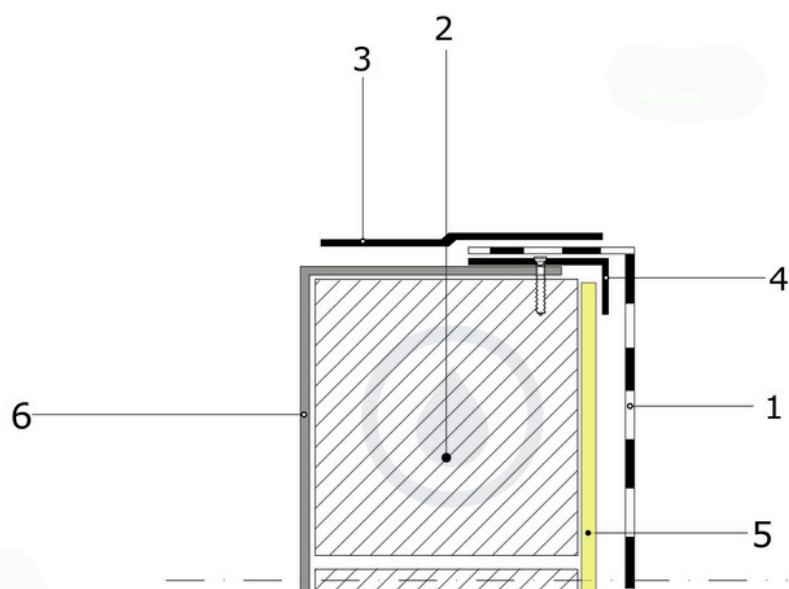

- 1. Sealtec TPO
- 2. Wand
- 3. EPDM Flashing
- 4. Gecoate lashoek
- 5. Geotextiel / SoftTouch Premium
- 6. Bestaande Folie

12. Aansluiting Haklin voegband

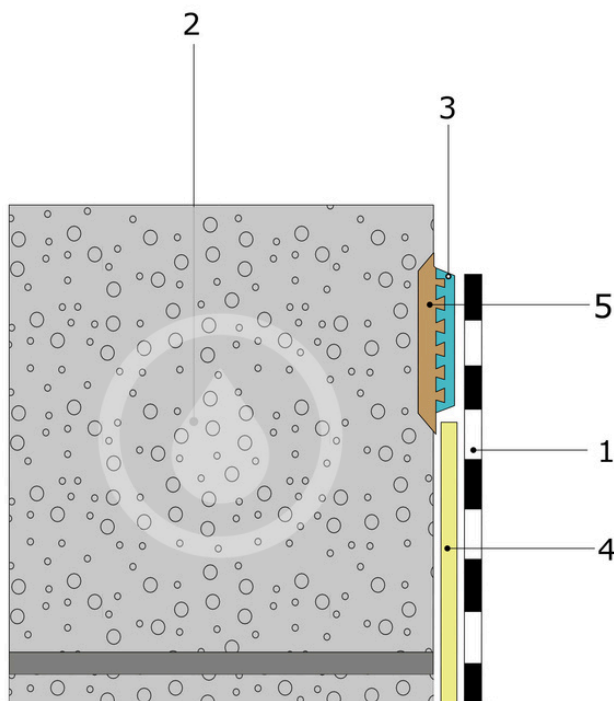
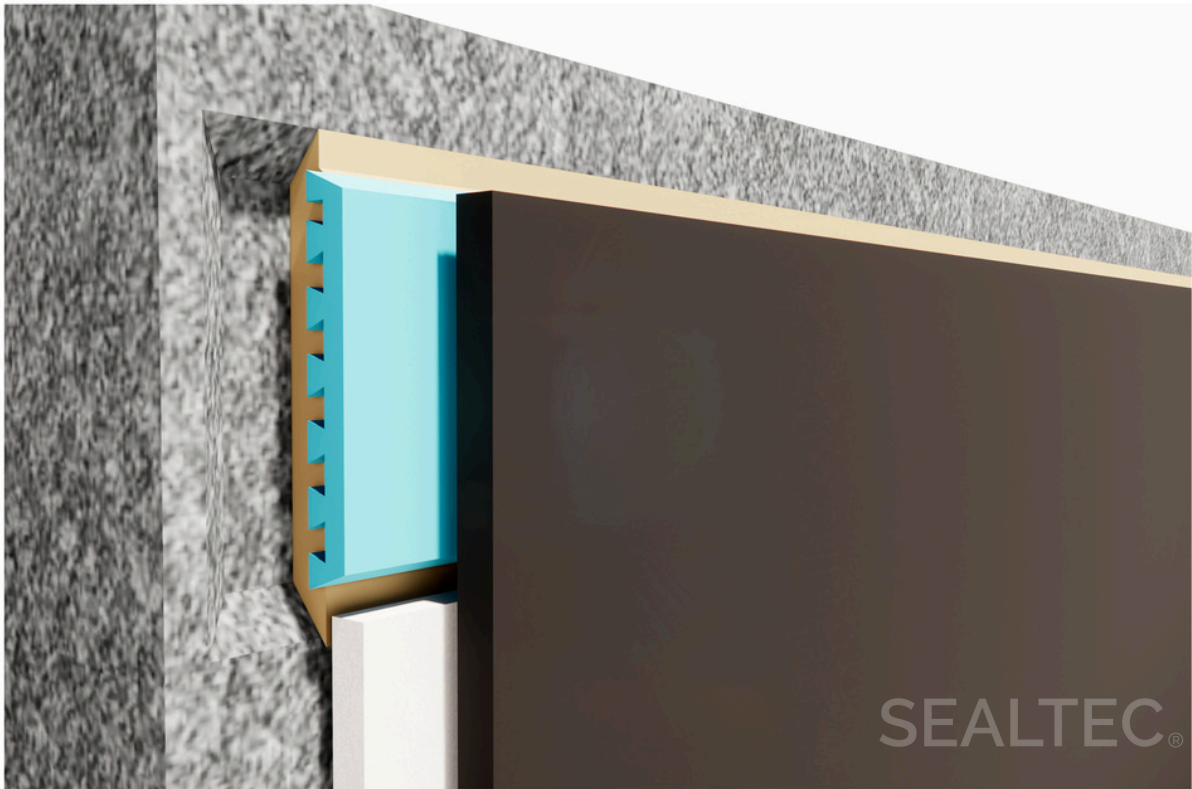

1. Sealtec TPO
2. Waterdichte beton
3. Haklin voegband
4. Geotextiel
5. Epoxyhars

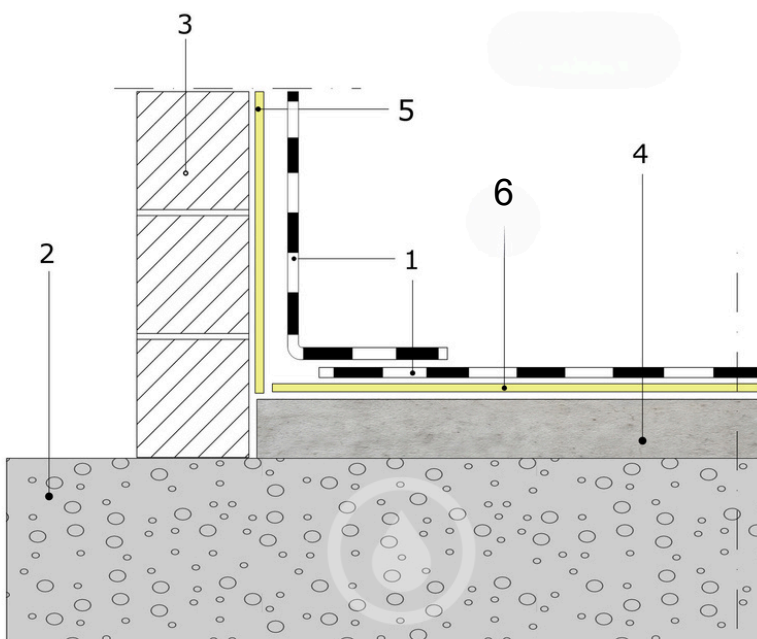

- 1. Sealtec TPO
- 2. Beton
- 3. Wand
- 4. Chape
- 5. Geotextiel / SoftTouch Premium
- 6. Geotextiel

Technische fiche:
13b. Principeschets vloeropbouw (VoW)

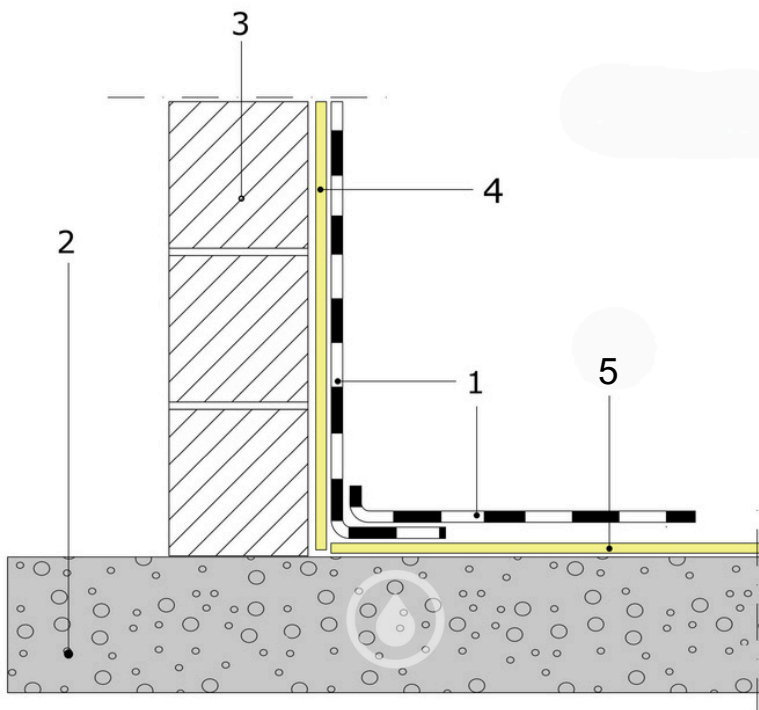

- 1. Sealtec TPO
- 2. Beton
- 3. Wand
- 4. Geotextiel / SoftTouch Premium
- 5. Geotextiel

SEALTEC[®]
sustainable waterproofing

Aarschot 3200
Nieuwland 111

016 19 71 60
www.sealtec.be

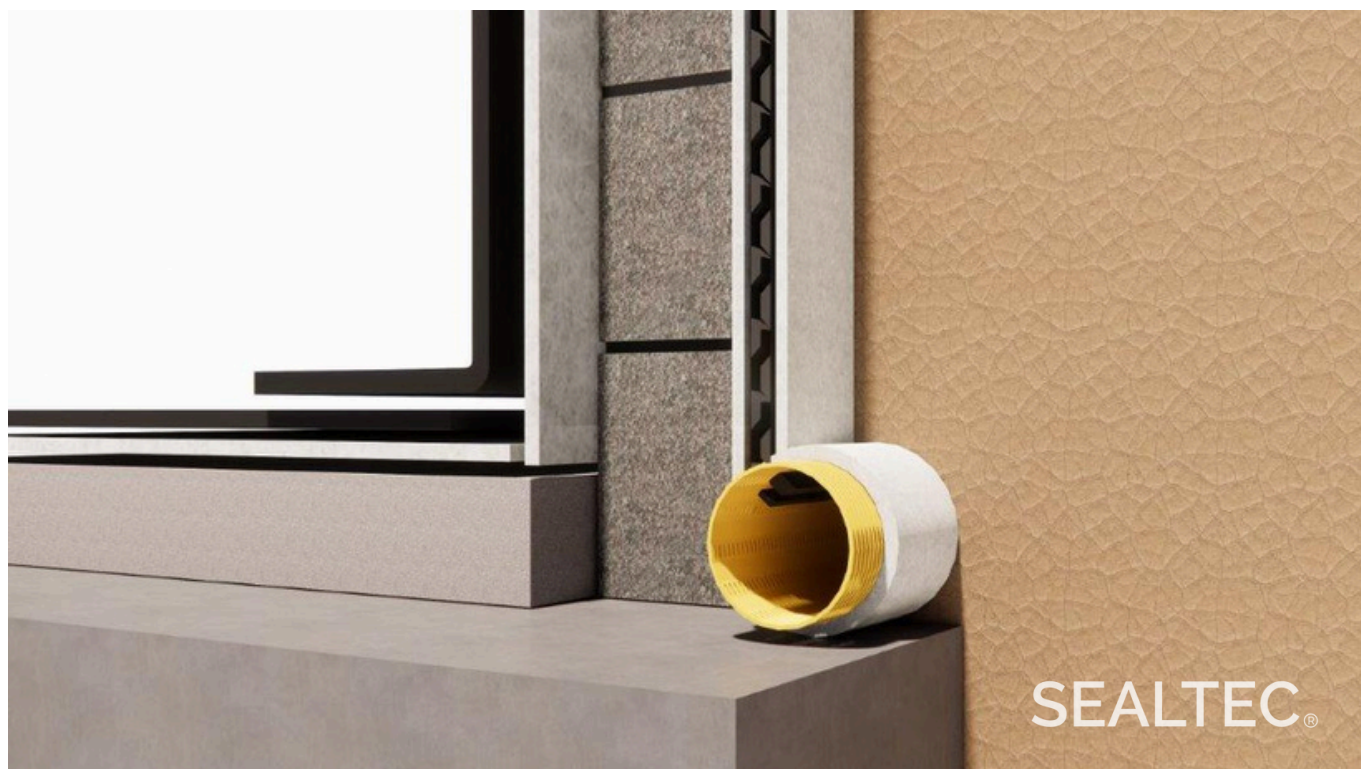

SEALTEC®

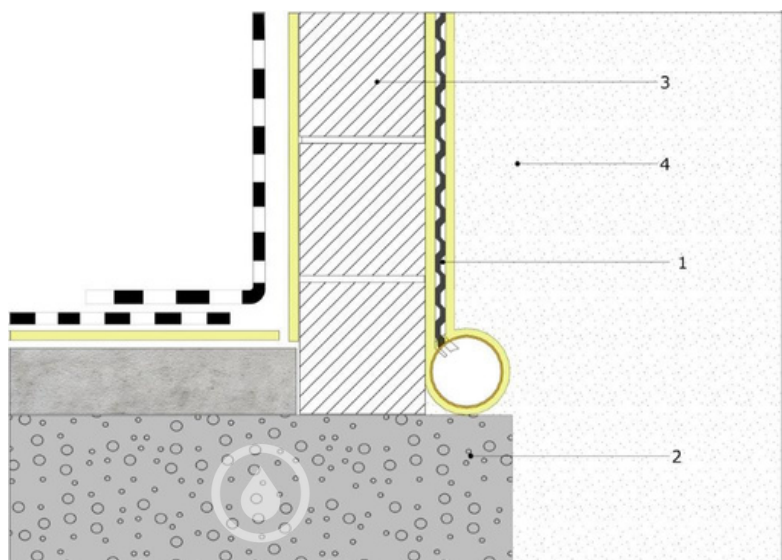

- 1. SealDrain
- 2. Beton
- 3. Wand
- 4. Waterdoorlatende backfill